

## Custom Cables and Adapters

**When you need it made to order,  
count on Black Box.**

- Cables, Adapters, Faceplates
- Pinning
- Striping
- Coloring
- Kitting
- Labeling
- Bundling
- Packaging
- Shipping
- Next-day, custom-length patch cables

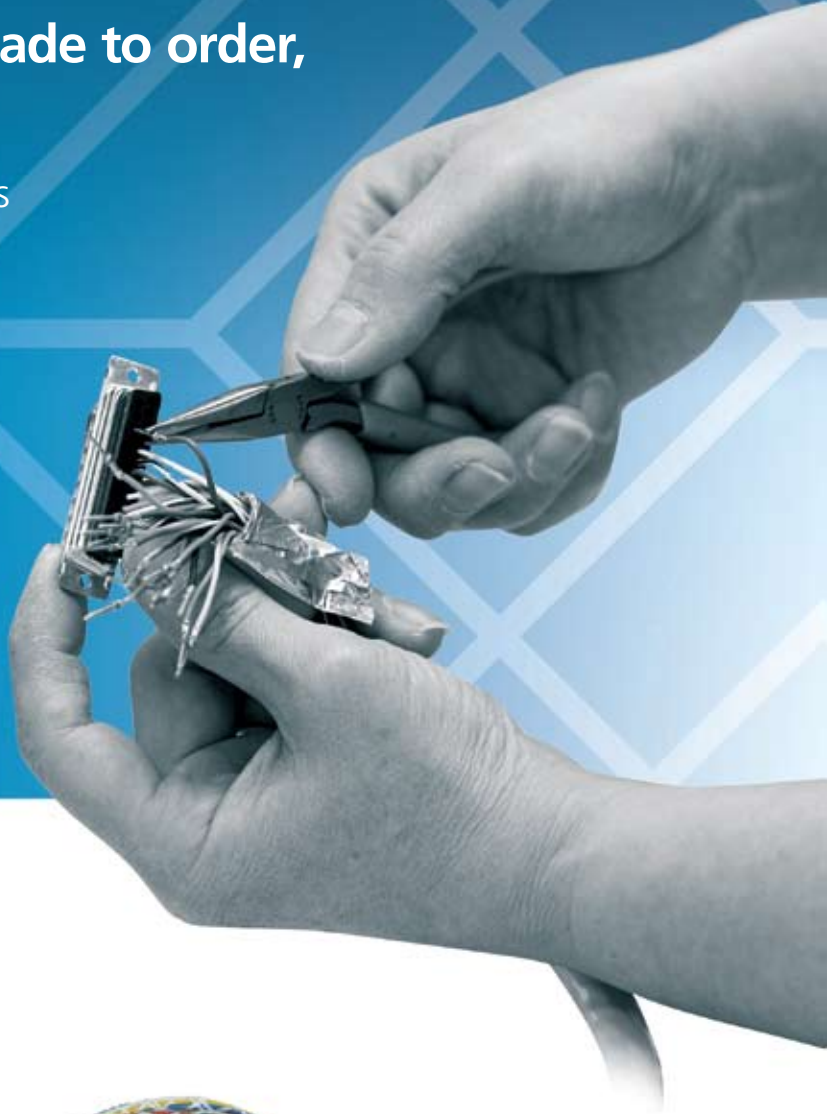

Specialized/custom cable



Custom striping/colors/bundling



Custom wallplates and adapters

# When you need the hard-to-find,

Can't find it anywhere? You'll find it at Black Box. If we don't stock it, we'll make it for you.

Sure, we offer more than 118,000 products every day in our catalogs and on [blackbox.com](http://blackbox.com). But when you're looking for more than an everyday solution, or when "off-the-shelf" just won't do, call Black Box.

For 35 years, Black Box has helped customers solve their unique connectivity problems.



*Special requirements are no problem. Every day, experienced technicians in our manufacturing facility in Lawrence, PA, build custom cable assemblies, wallplates, switches, and more.*



*Stay organized with custom labels. Let us know what you need, and we'll make them for you.*

Not only do we modify existing cables and adapters, we also build them from scratch to your specs! UTP, fiber optic, RS-232, coax, A/V—tell us what you need, and we'll turn your ideas into reality.

- We design and build more than 200,000 custom products each year.
- We produce more than 150,000 custom cables each year.
- We can provide custom pinning, labeling, packaging, kitting, and bar coding and ship your products according to your schedule.
- We can stripe, color, and bundle to your specs.
- We'll design custom fiber assemblies just for you.



*DB15 adapter modified with BNCs.*



*RJ-45 to DB9/wire ferrules octopus cable.*



*Need single-, dual-, 3-, or 4-gang wallplates? Tell us the connectors and configurations you need and we'll build them for you.*

# find it at Black Box.



*DB25 to BNC octopus cable.*

For 35 years, Black Box has helped customers solve their unique connectivity problems.

### Custom-length patch cables

Get exactly the length you need, when you need it. For details, see page 7.

## Some of our custom capabilities

### Bundled CAT5e and CAT6 Bulk Cable

Black Box saves you time by delivering bundled cables with the exact number of cables of the type and length you need. You can even specify color. Pull cable once and you're done. Ask about our bundled fiber cables, too.

### Dyed, striped, UV, and more

Camouflage? Company colors? Red, white, and blue? Show your colors with Black Box Custom Cable.

We provide you with just the kind of cable solution you need, whether it's special colors or striping for easy identification, or even cable that can stand up to the sun's UV rays.

### Custom cables

We've built custom cables with special snap-on/off connections for security

applications. We can also build custom Y and large octopus cables with extremely unusual connector combinations.

### Custom fiber colors

Choose from as many as 12 colors and get the convenience of standard part numbers, too. For details, see **page 6**.

### Adapters

Tell us the specific pairing, jumpers, and drains you need. Not sure? Describe your application, and our Tech Support experts will help you. We even do quick connect/disconnect adapters for industrial applications. Have legacy equipment and can't find adapters? We'll make them for you.

### Feed-through faceplates

Need custom faceplates for your conference rooms, classrooms, or digital signage

displays? Black Box can customize feed-through faceplates for your installation with the connectors of your choice: CAT5e, CAT6, fiber optic, VGA, audio, S-Video, and more.

### Labeling, kitting, shipping

Let us keep you organized. We'll label and bar code your order and provide exactly the packaging you want. We'll assemble kits of components to your specs, on your schedule.

To get started, just call our FREE Tech Support hotline or see our configurators at [blackbox.com/go/CableandAdapterCon](http://blackbox.com/go/CableandAdapterCon). After you submit your request to our engineers for review, a Black Box representative will contact you, typically within 24 hours with a quote.

# Connector Guide

## Connector Guide

### D-Style Connectors

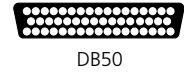
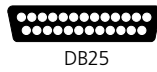

### Keyboard/Video/Audio

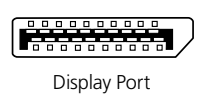
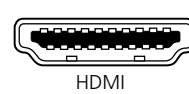
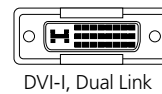
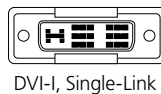
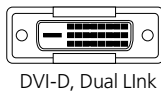
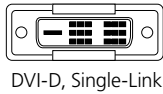
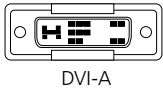
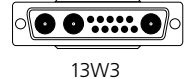

### Fiber Connectors

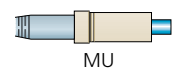
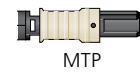
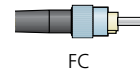
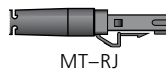
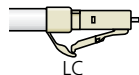
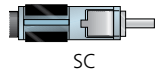

### USB & FireWire Connectors

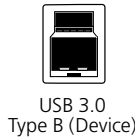
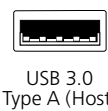
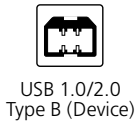

### Modular Connectors

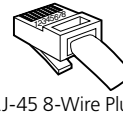
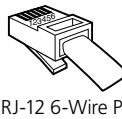
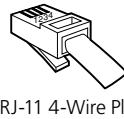

### DIN-Type Connectors



### Centronics Connectors

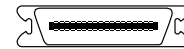
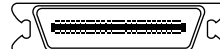
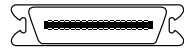

### SCSI Connectors

Need help identifying a connector?  
Call Tech Support!  
724-746-5500

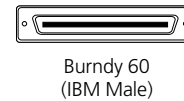
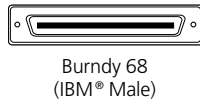
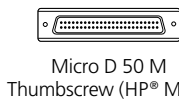
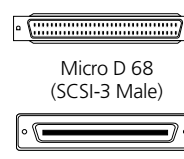
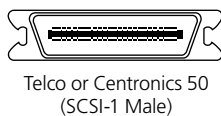

### M-Block Connectors



### Coax & Twinax Connectors

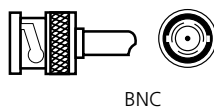
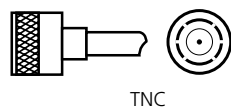

### Miscellaneous Connectors

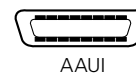
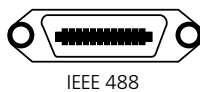

# Data Interface Pinning

## RS-232 Interface (DB25)

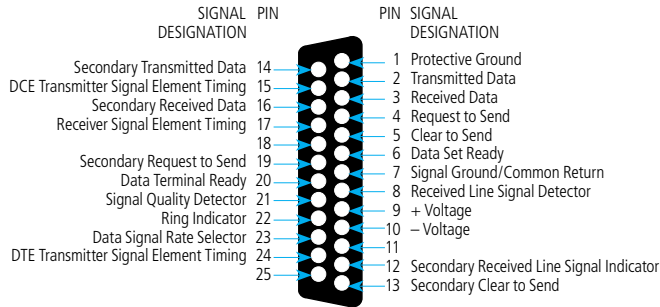

## RS-530 Interface (DB25)

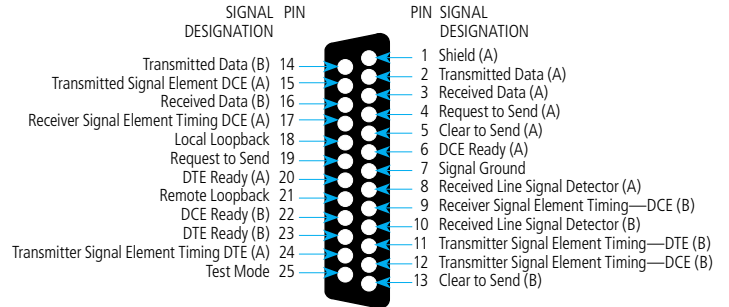

## RS-449 Interface (DB37)

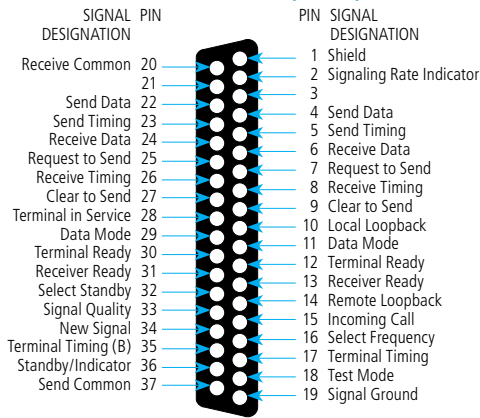

## V.35 Interface (M/34)

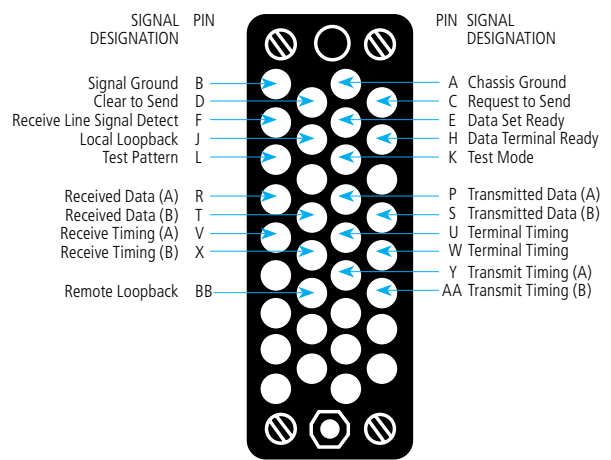

## Centronics® Parallel Interface

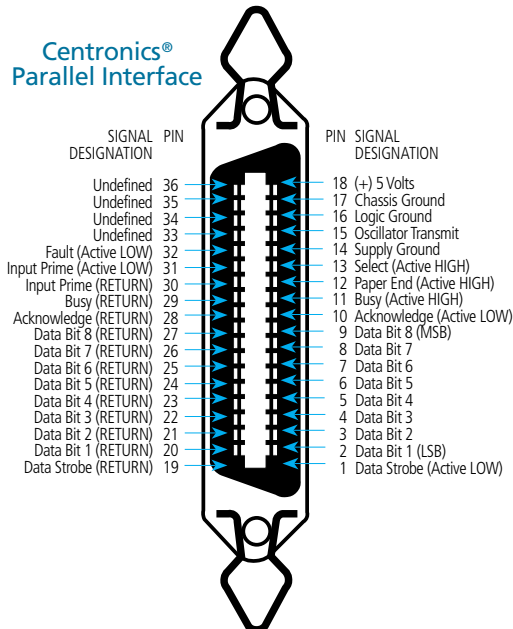

## VGA Video Interface (HD15)

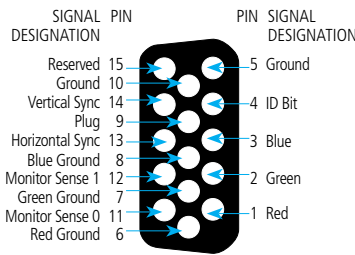

## RS-232 Interface (DB9)

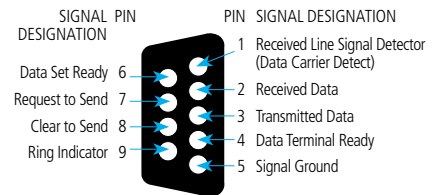

## IBM PS/2 Keyboard Interface (6-Pin Mini DIN)

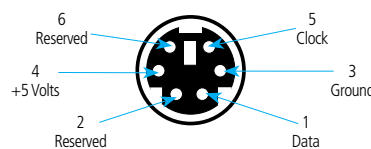

## USB Mini Type A

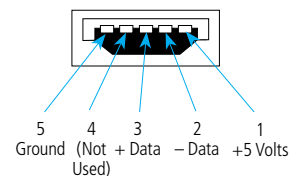

## USB Type A

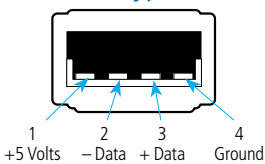

## USB Type B

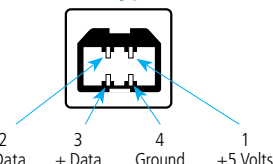

## USB Mini Type B

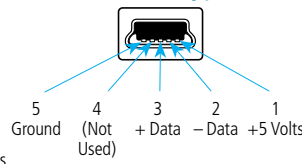

## USB Micro Type B

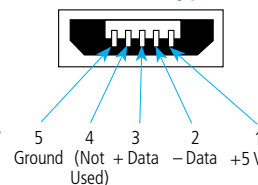

## USB Micro Type A/B

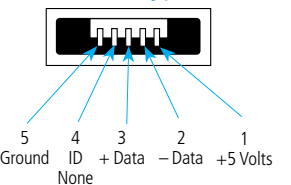

## Custom fiber with the convenience of standard part numbers.

Match Black Box fiber cable to your company, team, or school colors for that special networking application in the data center and the desktop. It's ideal for color-coded applications, too. Plus, it's guaranteed for life! Use the Buyer's Guide below to build your custom cable or go to [blackbox.com/go/CableandAdapterCon](http://blackbox.com/go/CableandAdapterCon).

Choose from as many as 12 colors!



### Buyer's Guide | Multicolor Fiber Optic Patch Cables

1 (Constant)	2 Jacket	3 Core Size	4 Length	5 M- (Constant)	6 Connectors	7 Color
FO	CMR = PVC CMP = Plenum	62 = 62.5 Micron 50 = 50 Micron SM = Single-Mode 10 = 10 Gig	001 = 1 Meter 002 = 2 Meters 003 = 3 Meters 004 = 4 Meters 005 = 5 Meters 006 = 6 Meters 007 = 7 Meters 008 = 8 Meters 010 = 10 Meters 015 = 15 Meters 020 = 20 Meters 025 = 25 Meters 030 = 30 Meters	M	STST = ST to ST SCSC = SC to SC LCLC = LC to LC MTMT = MT-RJ to MT-RJ STSC = ST to SC STLC = ST to LC STMT = ST to MT-RJ SCLC = SC to LC LCMT = LC to MT-RJ SCMT = SC to MT-RJ	BL = Blue OR = Orange GN = Green BR = Brown GR = Gray WH = White RD = Red BK = Black YL = Yellow VT = Violet PK = Pink AQ = Aqua
<b>Examples of fiber optic cable codes:</b> FOCMR62-001M-STST-BL = Cable with a PVC jacket, 62.5-micron core, 1-meter length, ST-ST connectors in blue. FOCMP50-008M-STLC-OR = Cable with a plenum jacket, 50-micron core, 8-meter length, ST-LC connectors in orange. FOCMRSM-030M-SCLC-YL = Cable with a PVC jacket, 9-micron core, 30-meter length, SC-LC connectors in yellow.						

NOTE: These cables are made to order. Orders cannot be canceled or returned.

## Misys Healthcare Systems: Custom Adapters

One of the many services and products Misys Healthcare Systems provides for healthcare organizations is software and instrumentation for medical laboratories.

Misys developed a new system for one of its clients that involved new instrumentation and software at three different sites. For the system to be properly connected, it required adapters with custom pinning. The Misys rep called Black Box and explained what type of adapters were needed. Black Box provided the quote and said the custom adapters would take a week or more.

Unfortunately, critical system testing was about to begin in a few days. When the Black Box rep heard about the tight time frame, she went the extra mile to get the adapters produced and shipped in two days—plenty of time for the system launch.

*"The crunch was on when the Black Box rep called back. She worked magic and was able to get the custom adapters out to us in two days—literally! Not only were we ecstatic, but the client was very happy and relieved. Awesome teamwork!"*

**Jaime Schisel**  
Instrument Specialist  
Misys Healthcare Systems

# Cable 911 Custom-Length Patch Cables

Order custom-length CAT5e/6 patch cables today—we'll ship today.  
Or, the cables are FREE\*!

Get exactly the length you need, when you need it.

Why compromise your work by using the wrong length cable? When you need custom-length patch cables overnight, call Cable 911 at Black Box. If we don't keep our promise to ship your cables today, you'll get your cables FREE\* (not including taxes, shipping, and handling).

Take the risk out of custom-length cables. With this exclusive new service, Black Box eliminates long lead times of days or weeks for custom cables. While others may say they offer same-day service, can you really afford to take a chance?

Call us today and you'll have your cables tomorrow. Plus, you'll save money by buying exactly what you need and no more.

### The details:

1. If you order by 1 P.M. ET Mondays–Fridays, we can ship your order that evening.
2. The maximum order is 50 cables per customer per day.
3. Cable 911 customers must be pre-approved credit customers or those buying with a credit card.
4. To order, you must call Customer Service at 724-746-5500. On-line orders will not be accepted.

### Cable options:

- CAT5e/CAT6
- Shielded/unshielded
- PVC/plenum (Plenum is only with solid conductors.)
- Snagless boot/basic connector
- Solid/stranded conductor
- Eight colors: blue, white, black, gray, green, orange, red, yellow
- Lengths: 1–99 feet

Cable 911: 724-746-5500.

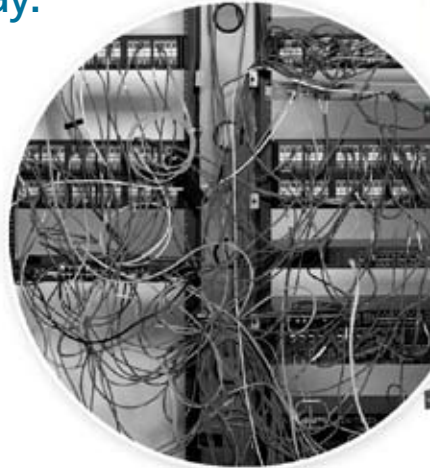

*Why settle for this mess when you can get exactly what you want tomorrow?*



### Cable 911 Custom-Length Patch Cables Ordering Example:

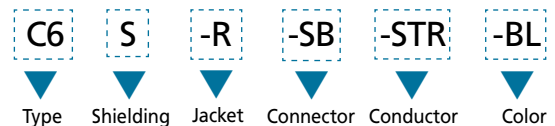

- 1 CAT5e (C5) or CAT6 (C6)
- 2 Shielded (S) or Unshielded (U)
- 3 PVC (R) or Plenum (P) (Plenum is only with solid conductors.)
- 4 Snagless Boot (SB) or Basic Connector (BC).
- 5 Solid Conductor (SLD) or Stranded Conductor (STR)
- 6 Color: Blue (BL), White (WH), Black (BK), Gray (GY), Green (GN), Orange (OR), Red (RD), Yellow (YL)

Ordering: Call 724-746-5500. Specify length when you order. Order maximum: 50 cables. Order by 1 P.M. ET Monday–Friday.

Custom-Cable Length Tolerances	
0–9.9 ft.	+3"/-0"
10–99.9 ft.	+6"/-0"
100 ft.+	+1 ft./-0"

# Custom Cable Request Form

(Page 1 of 2)

Create your own custom cable with this form by indicating cable type, length, and jacket type as well as connector gender, connector type, and special instructions. If you select foil shielded as the cable type, remember to circle your drain-wire option. Lastly, indicate your pinning requirements.

You can also configure Custom Cables with our Cable & Adapter Configurator at [blackbox.com/go/CableandAdapterCon](http://blackbox.com/go/CableandAdapterCon). After you've submitted the form, you'll receive a confirmation e-mail, and your quote will be completed within 24 hours. Need help? Call our FREE Tech Support at 724-746-5500.

## 1 Cable Type: (Check as many as apply)

- |   |  |
|---|--|
| <input type="checkbox"/> CAT5e                          | <input type="checkbox"/> 62.5/125- $\mu$ m Multimode Fiber     |
| <input type="checkbox"/> CAT6                           | <input type="checkbox"/> 50/125- $\mu$ m Multimode Fiber       |
| <input type="checkbox"/> CAT6a                          | <input type="checkbox"/> 50/125- $\mu$ m (OM3) Multimode Fiber |
| <input type="checkbox"/> Unshielded                     | <input type="checkbox"/> 8.5/125- $\mu$ m Single-Mode Fiber    |
| <input type="checkbox"/> Foil Shielded                  | <input type="checkbox"/> Simplex Fiber                         |
| <input type="checkbox"/> Foil and Copper-Braid Shielded | <input type="checkbox"/> Duplex Fiber                          |
| <input type="checkbox"/> Solid                          | <input type="checkbox"/> Other: _____                          |
| <input type="checkbox"/> Stranded                       |  |

**Jacket Type:**  
 PVC  Plenum

**Standard Cable-Length Tolerances**

0–9.9 ft.	+3"/-0"
10–99.9 ft.	+6"/-0"
100 ft.+	+1 ft./-0"

## 2 Connectors:

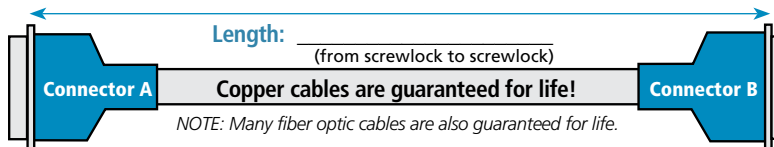

**Gender:** M  F

**Connector Type:** (Circle one)

- |                        |                            |                               |
|------------------------|----------------------------|-------------------------------|
| 1. DB9                 | 12. RJ-45 8-wire           | 22. Fiber FDDI                |
| 2. DB15                | 13. DEC™ MMJ               | 23. M/34 (V.35)               |
| 3. DB25                | 14. RJ-45 10-wire          | 24. 50-pin Berg:              |
| 4. DB37                | 15. RJ-45 8-wire, shielded | RS-232 or SCSI                |
| 5. DB50                | 16. M/50                   | 25. 4-pin mini DIN            |
| 6. 15-pin high-density | 17. Fiber ST®              | 26. 5-pin DIN                 |
| 7. 36-pin Centronics®  | 18. Fiber SC               | 27. 6-pin mini DIN            |
| 8. 50-pin telco        | 19. Fiber LC               | 28. 8-pin mini DIN            |
| 9. RJ-11 4-wire        | 20. Fiber MT-RJ            | 29. Spade lugs, length: _____ |
| 10. RJ-11 6-wire       | 21. Fiber MU               | 30. Other _____               |
| 11. RJ-22 4-wire       |                            |                               |

**Special Instructions:** (Circle options)

- One end cut
- Pins only
- Hood type (Plastic if not specified):
  - Metal hood
  - 45° hood
  - Plastic hood
  - Molded hood
  - Removable hood
- Thumbscrews
- Screw locks: M or F (Male if not specified) metric/English
- 90° hood—specify cable exit, Pin # \_\_\_\_\_  
NOTE: Default is Male=Pin 1, Female=Opposite
- Pairing
- Flying leads, length: \_\_\_\_\_
- Label: \_\_\_\_\_
- 50-pin telco: ears or bail latches
- 36-pin Centronics: ears or bail latches
- Packaging—please attach specs
- Other—please attach specs

**Drain Wire:** (Circle one)

(Applies only to foil-shielded cables)

- Cut drain wire
  - Pin drain by itself Pin # \_\_\_\_\_
  - Wrap drain with conductor Pin # \_\_\_\_\_
- If 1–3 are not chosen,
- Attach drain to shell

**Gender:** M  F

**Connector Type:** (Circle one)

- |                        |                            |                               |
|------------------------|----------------------------|-------------------------------|
| 1. DB9                 | 13. DEC MMJ                | 24. 50-pin Berg:              |
| 2. DB15                | 14. RJ-45 10-wire          | RS-232 or SCSI                |
| 3. DB25                | 15. RJ-45 8-wire, shielded | 25. 4-pin mini DIN            |
| 4. DB37                | 16. M/50                   | 26. 5-pin DIN                 |
| 5. DB50                | 17. Fiber ST               | 27. 6-pin mini DIN            |
| 6. 15-pin high-density | 18. Fiber SC               | 28. 8-pin mini DIN            |
| 7. 36-pin Centronics   | 19. Fiber LC               | 29. Spade lugs, length: _____ |
| 8. 50-pin telco        | 20. Fiber MT-RJ            | 30. Other: _____              |
| 9. RJ-11 4-wire        | 21. Fiber MU               |                               |
| 10. RJ-11 6-wire       | 22. Fiber FDDI             |                               |
| 11. RJ-22 4-wire       | 23. M/34 (V.35)            |                               |
| 12. RJ-45 8-wire       |                            |                               |

**Special Instructions:** (Circle options)

- One end cut
- Pins only
- Hood type (Plastic if not specified):
  - Metal hood
  - 45° hood
  - Plastic hood
  - Molded hood
  - Removable hood
- Thumbscrews
- Screw locks: M or F (Male if not specified) metric/English
- 90° hood—specify cable exit, Pin # \_\_\_\_\_  
NOTE: Default is Male=Pin 1, Female=Opposite
- Pairing
- Flying leads, length: \_\_\_\_\_
- Label: \_\_\_\_\_
- 50-pin telco: ears or bail latches
- 36-pin Centronics: ears or bail latches
- Packaging—please attach specs
- Other—please attach specs

**Drain Wire:** (Circle one)

(Applies only to foil-shielded cables)

- Cut drain wire
  - Pin drain by itself Pin # \_\_\_\_\_
  - Wrap drain with conductor Pin # \_\_\_\_\_
- If 1–3 are not chosen,
- Attach drain to shell

**COPY AND FAX THIS FORM TO 800-321-0746  
 OR VISIT BLACKBOX.COM/GO/CABLEANDADAPTERCON**





# Custom Wallplate Request Form

## Custom Wallplate Request Form

Create your own custom multimedia stainless steel wallplate for RJ-11, RJ-45, D-Sub, coax, audio, and video connections.

**1** Select a wallplate (one wallplate layout per form):

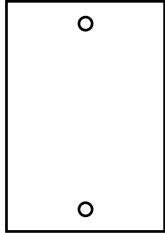

Single-Gang

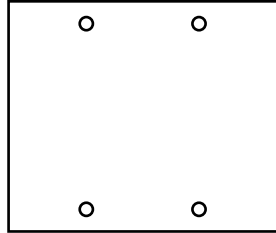

Dual-gang

**2** Select the connector types (write in quantity):

NOTE: The type and the number of connectors you choose may not all fit onto the selected wallplate. If you have any questions, contact Tech Support at 724-746-5500.

NOTE: The first gender indicates the wallplate's face gender.

**D-Style Feed-Through**

	DB9	DB15	DB25	HD15
Male/Female				
Female/Male				
Male/Male				
Female/Female				

**D-Style Solder Type**

	DB9	DB15	DB25	HD15
Male				
Female				

**DVI Adapters**

DVI-I/D/A Female/Female Qty: \_\_\_\_\_

**Coax Connectors (Female Only)**

	BNC	F-Type
Feed-Through		
Solder		

**Audio & Video (Female Only)**

RCA Quantity for each color(s):

Red \_\_\_\_\_ White \_\_\_\_\_  
 Yellow \_\_\_\_\_ Blue \_\_\_\_\_  
 Green \_\_\_\_\_ Black \_\_\_\_\_

	3.5 mm	¼"
Feed-Through, Mono		
Feed-Through, Stereo		
Solder-Type, Mono		
Solder-Type, Stereo		

HDMI (Feed-through) \_\_\_\_\_ S-Video (feed-through) \_\_\_\_\_

**RJ-45 or RJ-11 (110 Punchdown)**

CAT6 Quantity for each color(s):

Blue \_\_\_\_\_ Black \_\_\_\_\_ Ivory \_\_\_\_\_  
 Gray \_\_\_\_\_ Green \_\_\_\_\_ Office White \_\_\_\_\_  
 Orange \_\_\_\_\_ Red \_\_\_\_\_ Telco Ivory \_\_\_\_\_  
 White \_\_\_\_\_ Yellow \_\_\_\_\_

CAT5e Quantity for each color(s):

Blue \_\_\_\_\_ Black \_\_\_\_\_ Ivory \_\_\_\_\_  
 Gray \_\_\_\_\_ Green \_\_\_\_\_ Office White \_\_\_\_\_  
 Orange \_\_\_\_\_ Red \_\_\_\_\_ Telco Ivory \_\_\_\_\_  
 White \_\_\_\_\_ Yellow \_\_\_\_\_

CAT3 Quantity for each color(s):

Blue \_\_\_\_\_ Black \_\_\_\_\_ Ivory \_\_\_\_\_  
 Gray \_\_\_\_\_ Green \_\_\_\_\_ Office White \_\_\_\_\_  
 Orange \_\_\_\_\_ Red \_\_\_\_\_ Telco Ivory \_\_\_\_\_  
 White \_\_\_\_\_ Yellow \_\_\_\_\_

RJ-11 Quantity for each color(s):

Blue \_\_\_\_\_ Black \_\_\_\_\_ Ivory \_\_\_\_\_  
 Gray \_\_\_\_\_ Green \_\_\_\_\_ Office White \_\_\_\_\_  
 Orange \_\_\_\_\_ Red \_\_\_\_\_ White \_\_\_\_\_  
 Yellow \_\_\_\_\_

RJ-45 or RJ-11, Feed-through (Qty):

CAT5e \_\_\_\_\_ CAT6 \_\_\_\_\_ RJ-45 \_\_\_\_\_ RJ-11 \_\_\_\_\_

**3** Write the connector name where it should be positioned on the wallplate.

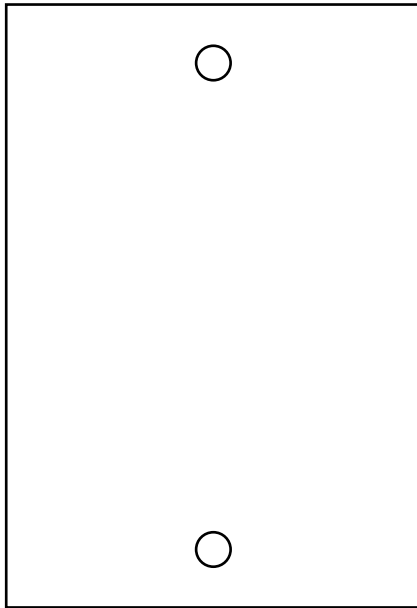

Single-gang

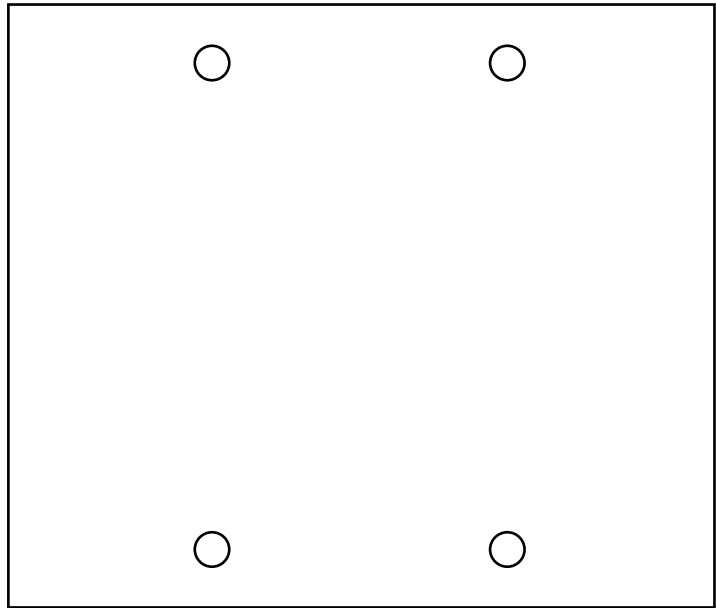

Dual-gang

Examples:

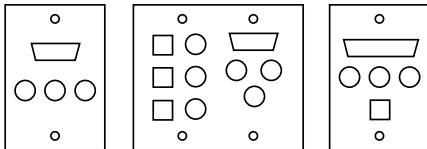

**4** Enter customer information and quantities.

Part number: \_\_\_\_\_ Name: \_\_\_\_\_  
 Contact number: \_\_\_\_\_ Title: \_\_\_\_\_  
 Quote number: \_\_\_\_\_ Company: \_\_\_\_\_  
 Order number: \_\_\_\_\_ Address \_\_\_\_\_  
 Comments: \_\_\_\_\_ or P.O. Box: \_\_\_\_\_  
 \_\_\_\_\_ Mail Stop/  
 \_\_\_\_\_ Suite/Building: \_\_\_\_\_  
 \_\_\_\_\_ City: \_\_\_\_\_  
 \_\_\_\_\_ State: \_\_\_\_\_ Zip: \_\_\_\_\_  
 \_\_\_\_\_ Telephone: (     ) \_\_\_\_\_  
 \_\_\_\_\_ Fax: (     ) \_\_\_\_\_  
 \_\_\_\_\_ E-mail: \_\_\_\_\_

**5 easy ways to order!**

1. Phone: 724-746-5500—  
24 hours a day, 7 days a week
2. On-line: [blackbox.com](http://blackbox.com)
3. E-mail: [orders@blackbox.com](mailto:orders@blackbox.com)
4. Fax: 800-321-0746
5. Mail: 1000 Park Drive,  
Lawrence, PA 15055-1018

**24-Hour Response!**

Quantity: \_\_\_\_\_

*Thank you!*